

Wallaby

warmer



User Manual

MD Infant Radiant Warmer

Wallaby

Effective date: 05 December 2024
Issue Number: 01 Version: 15 EN
Issue Date: 05 December 2024

CE 2265

Contents

Company Information	04
Warnings	05
Introduction	06
Safety Information	07
Device Description	09
Setting up Warmer	11
Using Warmer	14
Alarm System	22
Cleaning	23
Maintenance	25
Disposal	27
Specifications	28
Explanation of Symbols	30
Warranty Policy	31

Company Information



MEDICAL TECHNOLOGY TRANSFER AND SERVICES Co., LTD
House No. 26, Alley 41, An Duong Vuong Street, Tay Ho District,
Hanoi City, Vietnam
SRN: VN-MF-000036669

Tel: +84 24 3766 6521
Fax: +84 24 3718 8050
Email: assistance@mtts-asia.com
www.mtts-asia.com



Logic s.r.l.
Via Antonio Pigafetta 1
34147 Trieste, Italy
SRN: IT-AR-000012301

Warnings

Warnings

- Do not modify this equipment without authorization of the manufacturer.
- To avoid risk of electric shock, this equipment must only be connected to a supply mains with protective earth.
- Regularly check side panels are securely locked in the vertical position.
- Independent monitoring of the temperature is essential for any baby under an infant radiant warmer.
- Thermal radiation from the radiant warmer may cause increased insensible water loss and skin burns to the patient. Do not leave the patient unattended under radiant warmer.

Introduction

Intended purpose

The Wallaby Warmer device is intended to provide a controlled source of heat and maintain the body temperature for neonates and infants. The Wallaby Warmer device is for use in the hospital settings.

Intended users

- a) Qualified medical professional with experience in neonatal care
- b) Knowledge (minimum):
 - Understands basic principles of radiant warmer
 - Understands the specialized care needed for pre-term and full-term neonates

Intended patient population

- Age: Premature and full term neonates
- Weight: < 10kg

Indications

The device is indicated for thermoregulation, skin temperature regulation.

Contraindications

There are some contraindications to neonatal radiant warmer devices:

- Infants with circulatory compromise – severe hypothermia, sepsis
- Infants with serious skin damage.
- Infants with brain damage, asphyxia, hydrocephalus: thermo-regulation centre in brain may be permanently damaged, thus mask signs of temperature instability.
- Infants with severe respiratory distress, uncorrected congenital heart defects, and severe dehydration

Limitations

- The effectiveness of the Wallaby Warmer may be reduced in rooms with unstable ambient temperatures or high air circulation.
- For single-patient use only, with a maximum weight of 10 kg.
- Patient height must be less than 65 cm.
- The Wallaby Warmer does not provide humidified ambient.

Clinical Benefit

The clinical benefit to be determined is to maintain the target patient's temperature with an accuracy of 98.5% over average 1 hour of ongoing treatment.

Side effects

None

NOTE: Any serious incident that has occurred in relation to the device should be reported to MTTs and the competent authority of the Member State in which the user and/or patient is established.

Safety Information

- The presence of electro-surgical devices, shortwave or microwave equipment near this device could lead to electrical interference that negatively affects the function of the device.
- The device is not suitable for use in presence of flammable anaesthetic gases or other flammable materials, such as some types of cleaning fluids.
- The device cannot distinguish between an increase in body core temperature when the skin is cold (e.g., with a fever) and a low body core temperature (e.g., with hypothermia). Ensure the clinical condition of the baby is regularly reviewed.
- It is inadvisable to leave a baby unattended under infant radiant warmer.
- The heat emitted by a radiant warmer may increase baby's insensible water loss. Consider appropriate measures to maintain proper fluid balance.
- Do not use an axillary or rectal temperature sensor measurement to control baby skin temperature. Use of axillary or rectal temperature sensor measurement to control baby skin temperature can result in over-heating or under-heating of the baby.
- The warmer does not adjust for patient temperature in PREWARM MODE. PREWARM MODE delivers less than 10mW/cm² irradiance across mattress.
- A baby's thermal balance can be affected by ambient conditions. Do not place an infant radiant warmer in direct sunlight, near another heat source, or in draughty conditions.
- Tilting the bed from the horizontal position can affect warmer performance by altering the heat distribution across the bed mattress.
- Do not leave the baby unattended in the bed when the side panels are folded down.
- Maximum bed loading is 10kg.
- Maximum IV hook loading is 2kg.
- Maximum sidetray loading is 5kg.
- Maximum storage shelf loading is 5kg
- The Wallaby Warmer does not adjust for patient temperature in PREWARM MODE. When a baby is placed under the warmer, either MANUAL or BABY MODE should be selected immediately.
- Ensure only approved replacement parts are used during service and maintenance procedures.
- Please contact an authorised MTTs representative for further assistance with any servicing or maintenance requirement.

Safety Information

- Position the device so that the power plug is readily accessible at all times.
- The device is intended for use only by appropriately trained personnel and under the direction of qualified medical personnel who are familiar with currently known risks and benefits of radiant warmer use.

Device Description

Overview

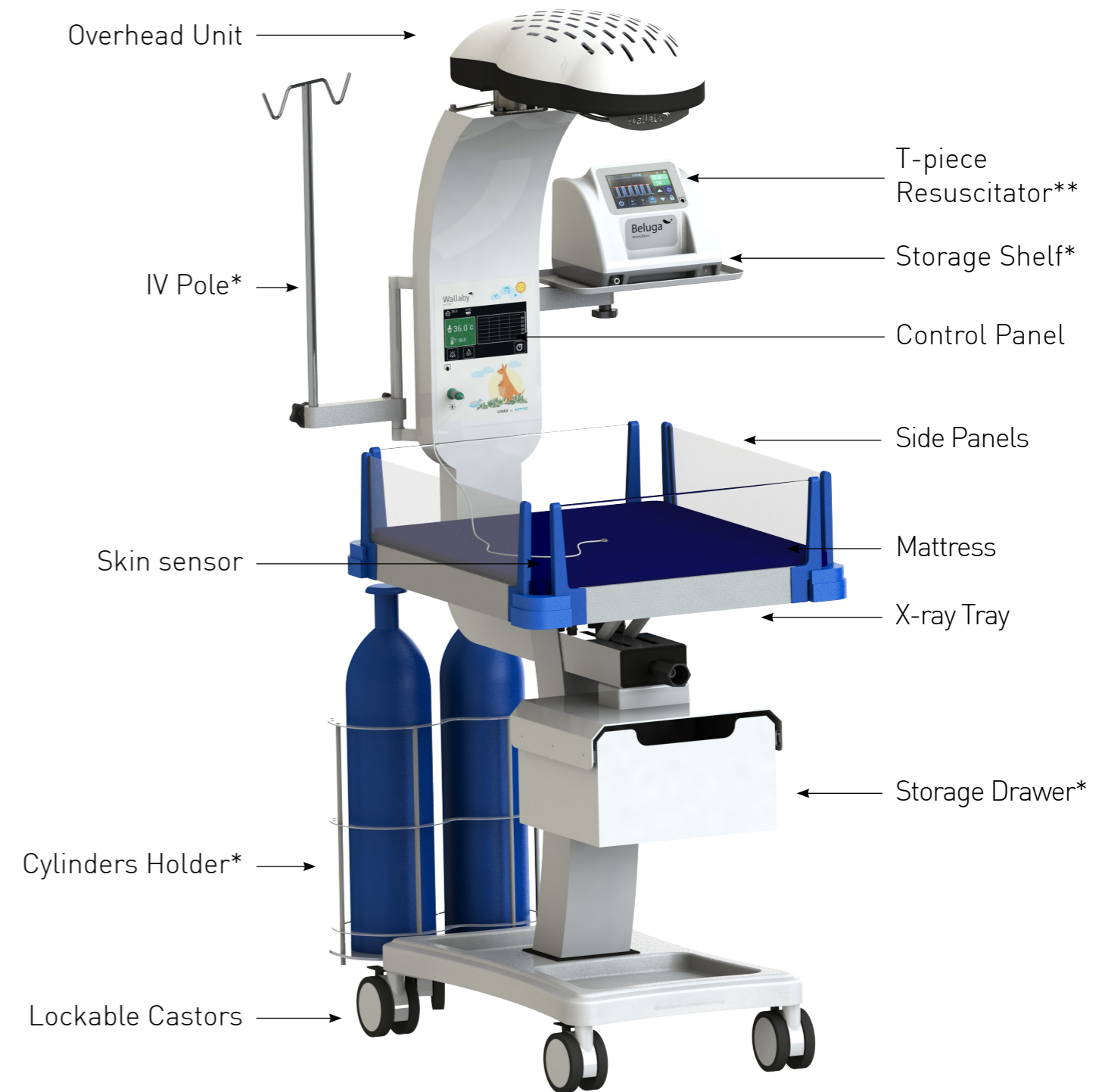

* Optional components

** Not included, illustration only

Device Description

Control Panel

Wallaby Warmer functions are controlled by touch screen.

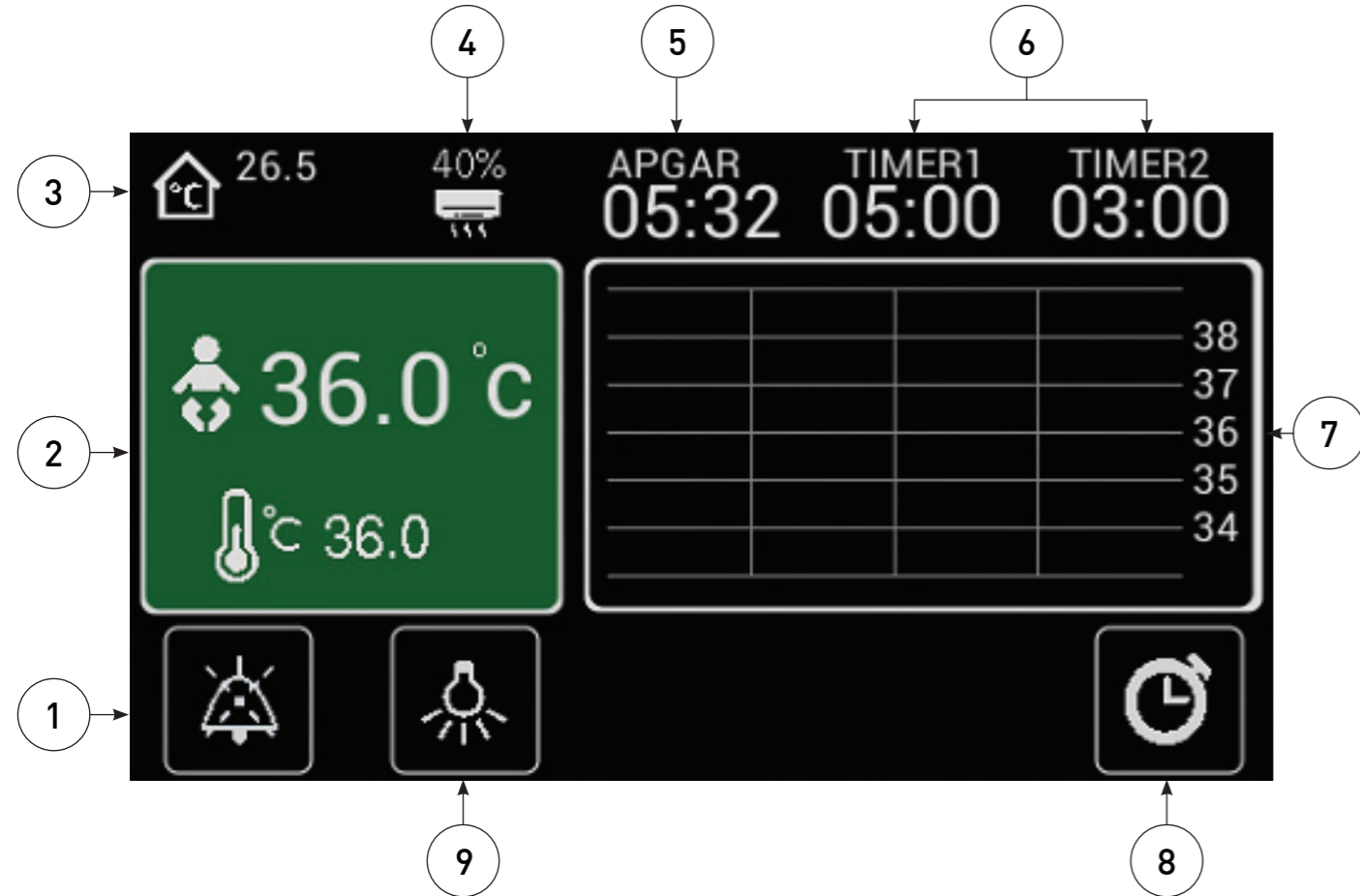

1	Alarm Mute	Touch this symbol to mute the alarm for 10 minutes
2	MODE Selection Panel	Displays set values and actual values in different MODES Touch this panel to select operational modes (MANUAL, BABY, PREWARM)
3	Ambient Temperature	Displays ambient temperature in °C
4	Heater Power	Displays heater power
5	APGAR Timer	Displays APGAR Timer
6	Procedure Timer	Displays Procedure Timers
7	Temperature History Chart	Displays 5 minute Set Temperature and Baby Temperature history
8	Timer	Touch this symbol to enter APGAR and Procedure Timers selection screen
9	Examination Light	Touch this symbol to enter light adjustment screen

Setting up Warmer

STEP 1 - Remove components from the box

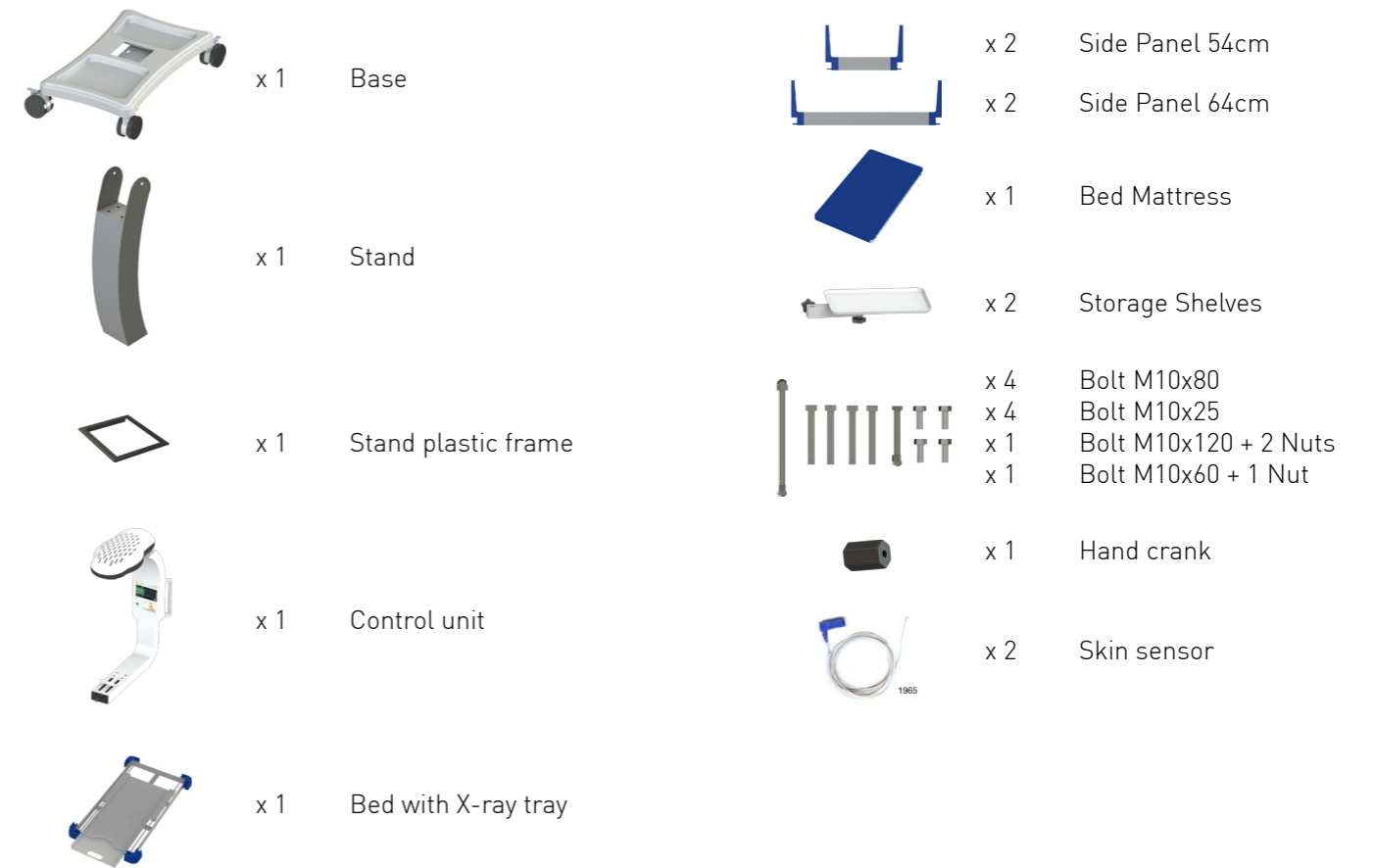

The list excludes optional components. Refer to STEP 3 and STEP 8 for more information.

STEP 2 - Attach Stand to Base

NOTE: Two people might be required to perform this step

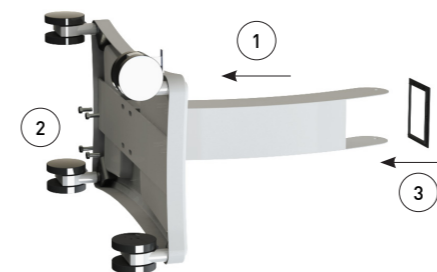

STEP 3 - Attach Cylinders Holder (Optional)

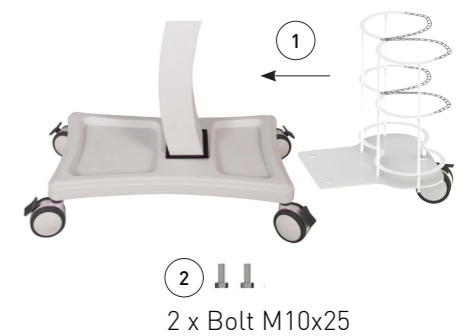

Setting up Warmer

STEP 4 - Attach Control Unit to and Hand Crank to Stand

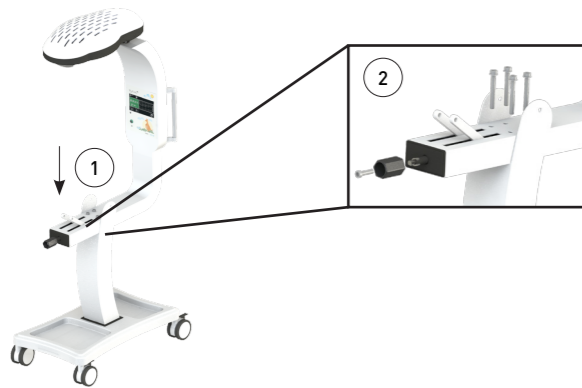

NOTE: Two people might be required to perform this step

STEP 5 - Attach Side Panel to Bed

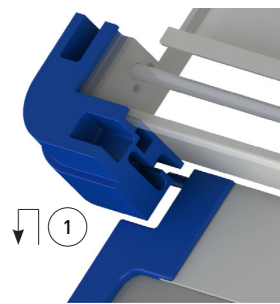

NOTE: Attach only side panel that is closest to the Control Unit in this step. Remaining panels will be attached in STEP 7

STEP 6 - Attach Bed

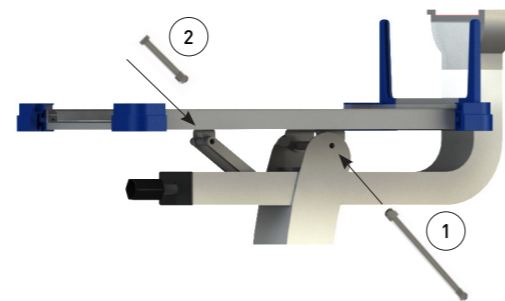

STEP 7 - Attach 3 remaining Side Panels to Bed

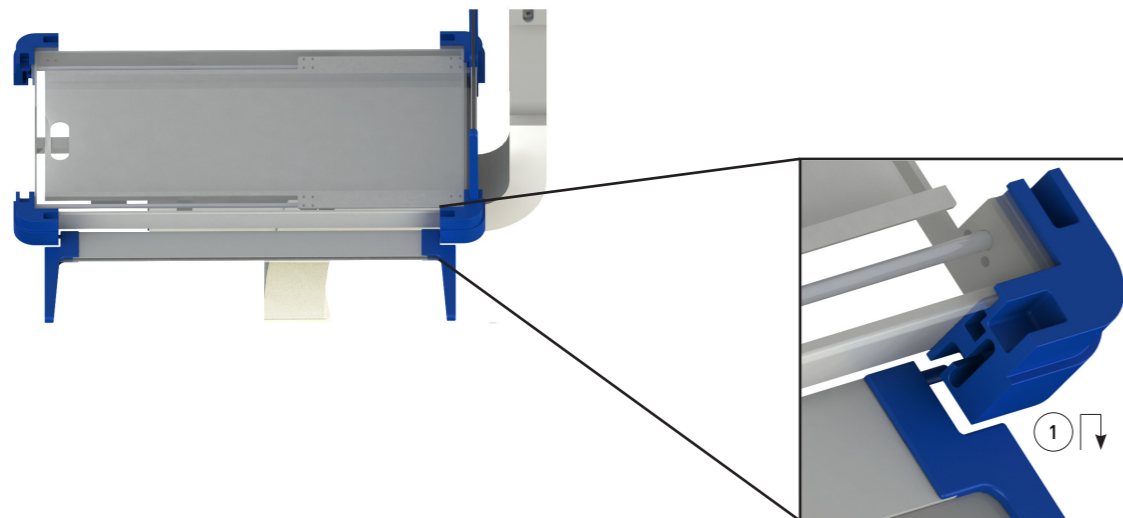

Setting up Warmer

STEP 8 - Attach Optional Components

NO	NAME	ORDER NO
1.	IV Pole	WLB-1030
2.	Storage Shelf	WLB-1040
3.	Storage Drawer	WLB-1050
4.	Cylinders Holder	WLB-1060 (see STEP 3)

3A Disconnect top and bottom parts
Press black latch on both sides and slide out

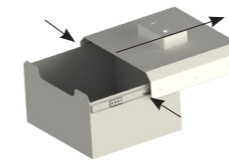

3B Attach the top part to the control unit
Use 2 x Bolt M10x25



3C Connect the bottom part
Slide in until you hear a 'click' sound

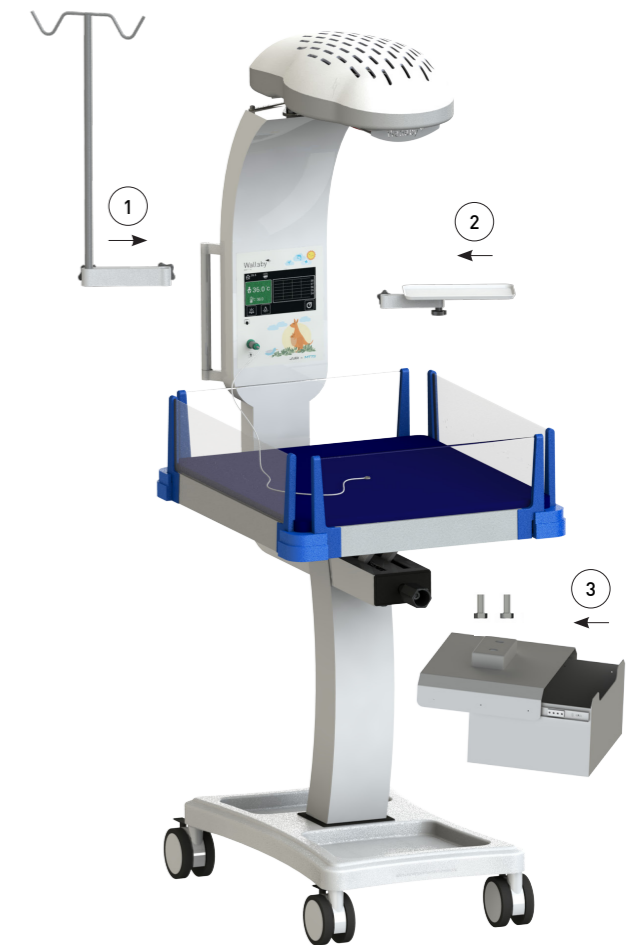

STEP 9 - Plug in and power up

The connector plugs into the back of the Wallaby Warmer Control Unit and then directly into the power outlet in the wall.

NOTE:

- Only use power cords and connectors provided by MTTs.
- Wallaby Warmer should only be used with the power outlets that have a protective earth (ground) pin.
- Make sure to remove the bubble wrap from the heater element before the first use

Using Warmer

Starting the therapy

- Move the rocker switch located at the back of the control unit to the 'ON' position
- The device will start automatically in the mode that was last used.



Touch MODE Selection panel to enter MODE Selection screen

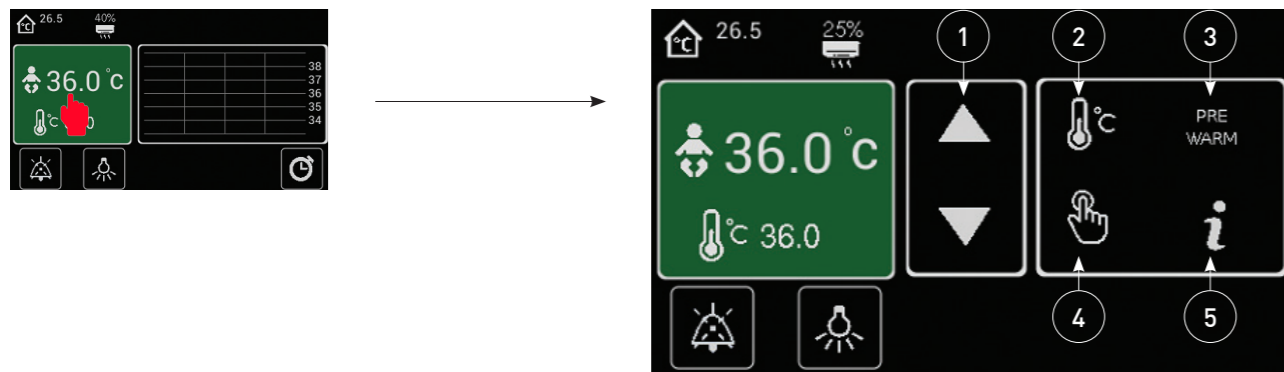

1	Set value adjustment	Touch the arrow up or down to adjust set temperature or heater power
2	BABY MODE	Touch this symbol to select BABY MODE
3	PREWARM MODE	Touch this symbol to select PREWARM MODE
4	MANUAL MODE	Touch this symbol to select MANUAL MODE
5	Information	Touch this symbol to display information about the device

Placing the Skin Sensor

1. Gently clean and dry the baby's skin where you intend to place skin sensor.
2. Place the shiny side of the skin sensor against the baby's skin in desired location.
3. Tape over the sensor using medical grade adhesive tape.

NOTE

- The warmer cannot measure or control the baby's skin temperature if the skin sensor is not correctly positioned on the baby.

Using Warmer

Using BABY MODE

Whenever possible, use the warmer in the Baby Mode.

BABY MODE provides stable control of the baby's skin temperature by automatically adjusting the heater power to compensate for varying metabolic and environmental conditions. By measuring and updating the baby's temperature five times per second, BABY MODE provides optimal thermoregulation and is recommended as preferred mode of maintaining the patient's body temperature.

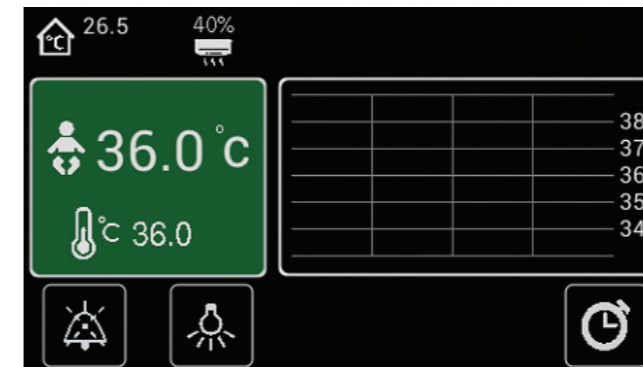

1. Push the skin sensor plug firmly into the front panel socket.
2. When the baby arrives, place on the warmer mattress and correctly attach the skin sensor.
3. Select BABY MODE from the MODE Selection screen.
4. Set the desired skin temperature between 34°C and 37.5°C by touching the up/down arrows on the front panel. The set temperature is displayed below the baby symbol.
5. With the skin sensor plug correctly inserted into the front panel socket and the skin sensor correctly positioned on the baby, the baby's skin temperature is displayed next to the baby symbol.

The warmer will now automatically adjust the heater power to stabilise the baby's skin temperature at the desired set temperature.

NOTE

- Independent monitoring of the temperature is essential for any baby under an infant radiant warmer.
- A warmer cannot differentiate between hypothermia (low skin and low core temperature), and fever (low skin and high core temperature). Ensure the clinical condition of the baby is regularly reviewed.

Using Warmer

- If the baby's skin temperature is less than the set temperature when BABY MODE is first selected, the LOW SKIN TEMPERATURE alarm is disabled for 10 minutes or until the baby's skin temperature has warmed up to the set temperature.
- The 10 minute warm-up period enables safe continuous warming of the baby without nuisance alarms.
- The baby's weight, age, clinical condition, and other metabolic and environmental factors, will affect the time required to stabilise at the desired set temperature.
- Allow 5 to 10 minutes for the baby's skin temperature to stabilise after set temperature adjustments.

Using Warmer

Using PREWARM MODE

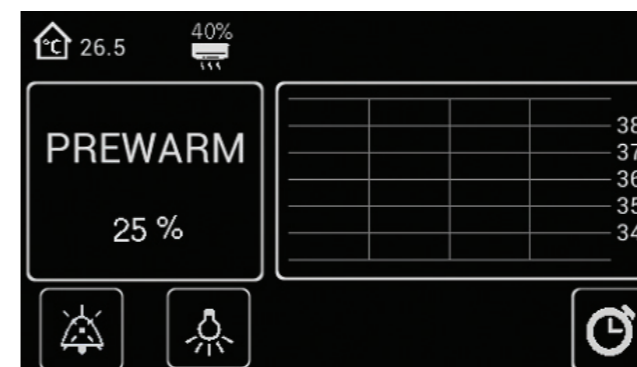

PREWARM MODE provides alarm and trouble free prewarming of the heater and environment above the warmer mattress before the arrival of the baby.

PREWARM MODE should be selected at least 5 minutes before the baby is placed on the warmer. It may also be used to provide low power background heating when required.

NOTE

- The Wallaby Warmer does not adjust for patient temperature in PREWARM MODE. When a baby is placed under the warmer, either MANUAL or BABY MODE should be selected immediately.

Using Warmer

Using MANUAL MODE

MANUAL MODE provides user-adjustable heater power, and the option to monitor the baby's skin temperature using skin sensor or independent temperature monitor.

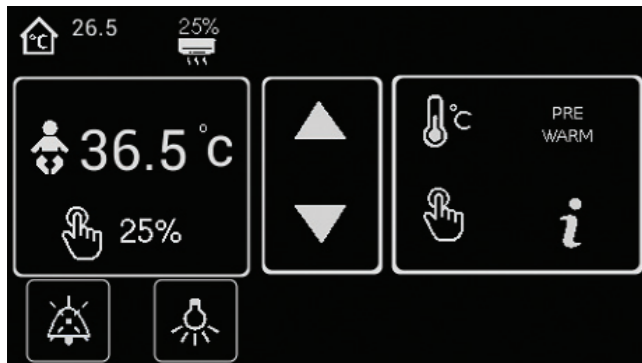

1. Select MANUAL MODE from the MODE Selection screen.
2. Set the desired heater power level between 0% and 100% by touching the up/down arrows on the front panel. The heater power level is displayed next to the heater symbol.
3. When using MANUAL MODE the baby's skin temperature should be monitored using an independent temperature monitor.

NOTE

- Independent monitoring of the temperature is essential for any baby under an infant radiant warmer.
- When using the warmer in MANUAL MODE continuously monitor the baby's clinical condition and skin temperature using independent temperature monitor.
- If the warmer is in MANUAL MODE for longer than 15 minutes, the Mode Screen will flash and audible alarm will sound, and the heater power will be reduced to 25%.
- If the ALARM MUTE button is now pressed, the Mode Screen flashing will be extinguished, the audible alarm silenced and the heater power will be restored at the set level.

Using Warmer

APGAR and Procedure Timers

The APGAR timer provides easy timing of APGAR scores. APGAR tones sound at 1, 5 and 10 minutes (10 pulse burst, followed by 0.5 second delay). The APGAR timer switches off after 60 minutes.

The two timer provide simple count-down timing of clinical procedures, each sounding a tone at the completion of their preset period. Both timers can be independently preset from 1 to 99 minutes.

Touch Timer symbol to enter APGAR and Procedure Timers selection screen

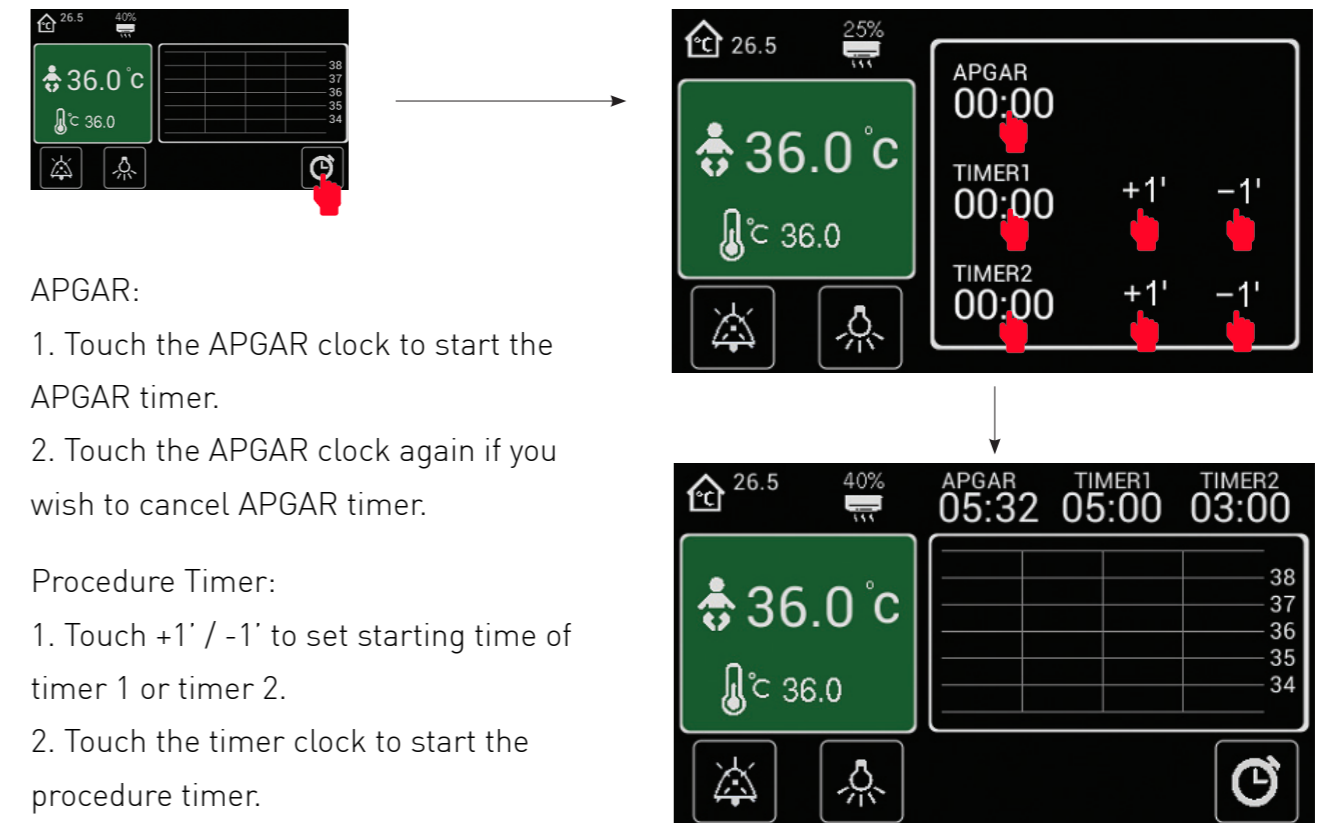

APGAR:

1. Touch the APGAR clock to start the APGAR timer.
2. Touch the APGAR clock again if you wish to cancel APGAR timer.

Procedure Timer:

1. Touch +1' / -1' to set starting time of timer 1 or timer 2.
2. Touch the timer clock to start the procedure timer.

The device will come back to original screen after 3 seconds.

Using Warmer

Examination Light

Touch Examination Light symbol to enter light adjustment screen

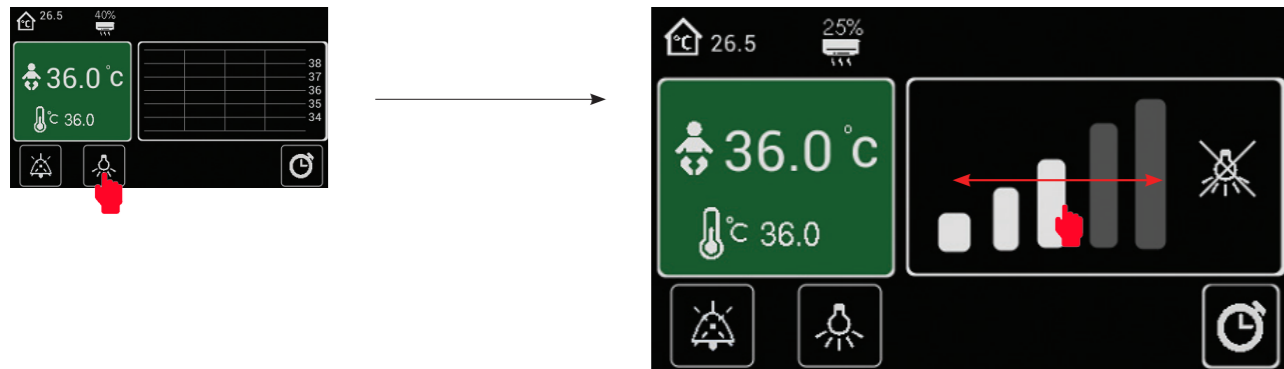

Move across the bargraph to adjust the light intensity.
The device will come back to original screen after 3 seconds.

Baby Bed

Baby bed provides the support platform for the mattress, which in turn provides comfortable and thermally insulated surface for nursing and caring for the baby. The bed can be continuously adjusted from -12° to +12°, to achieve Trendelenburg and Fowler type positions.

1. Turn the knob underneath the bed clockwise to move the front of the bed up.
2. Turn the knob underneath the bed counter-clockwise to move the front of the bed down.

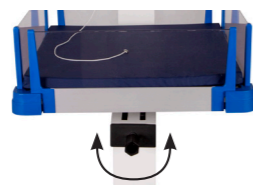

Baby bed is equipped with X-ray tray which is placed in the slot below it.

Using Warmer

Overhead Unit

Overhead unit can be moved to the right or left in order to perform X-ray procedure.

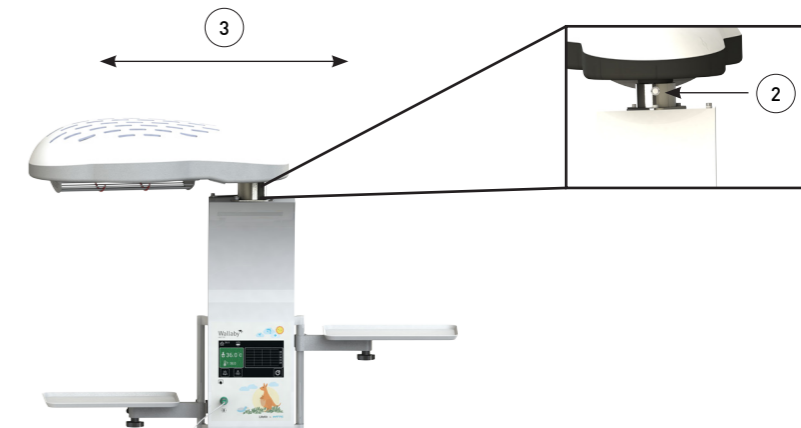

1. Turn the device off
2. Lift the overhead unit up.
3. Move overhead unit left or right.

Turning off the Warmer

1. Move the rocker switch located at the back of the control unit to the 'OFF' position.
NOTE: The action will activate POWER FAILURE alarm



2. Touch MODE Selection panel to enter MODE Selection screen

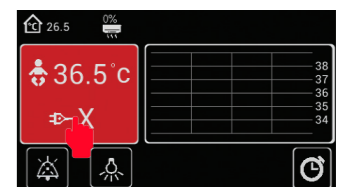



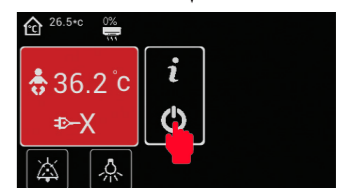

3. Press and hold the OFF symbol for 3 seconds

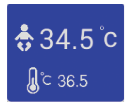

Alarm System

General

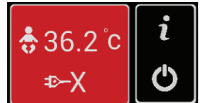
All the alarms are displayed on the Mode Selection Panel

Alarm	Mode	Cause	Effect	Mute Button
HIGH SKIN TEMP 	BABY	Measured skin temperature higher than set temperature by 1°C	Heater power disabled	Silences audible alarm only
	MANUAL	Measured skin temperature higher 38°C	Heater power disabled	Silences audible alarm only
	PREWARM	Not active	Not active	Not active
LOW SKIN TEMP 	BABY	Measured skin temperature lower than set temperature by 1°C (The skin sensor may have been detached or is incorrectly positioned)	Heater reduced to 25% of power	Cancels alarm and restores heater power
	MANUAL	Not active	Not active	Not active
	PREWARM	Not active	Not active	Not active
SENSOR DISCONNECT 	BABY	Skin sensor unplugged or faulty	Heater reduced to 25% of power	Silences audible alarm only
	MANUAL	Not active	Not active	Not active
	PREWARM	Not active	Not active	Not active
POWER FAILURE 	ALL	Power supply to Warmer failed	Warmer disabled	Silences audible alarm only
ERROR 	ALL	Software or hardware failure (refer to Technical Manual for more information on error codes)	Warmer disabled	Silences audible alarm only

Alarm system test

All the alarms listed above are considered MEDIUM PRIORITY except Power Failure alarm which is considered HIGH PRIORITY (ref. IEC 60601-1-8).

In order to verify the operation of auditory and visual alarms, perform the following procedure:

1. In Baby control mode, unplug skin sensor
2. Check indicator flashes on display and audible alarm sounds
3. Move mains witch to off position
4. Check power failure audible alarm sounds

Cleaning

General

Clean Wallaby Warmer either weekly or between patients using the following cleaning procedures:

- Comply with hospital, local and national guidelines for product cleaning frequencies.
- Cleaning shall be performed at ambient conditions. Allow heated surfaces to cool for at least one hour or cool to the touch before cleaning.
- Before cleaning, remove and discard all used disposable products using recommended method of disposal.
- Dust all surfaces with clean damp soft cloth.
- Clean all plastic surfaces with detergent based solution (maximum 2% in water) ensuring the manufacturer's directions for use of the cleaning agent are followed.
- Dry all the surfaces after cleaning with a clean soft cloth or paper towel.
- Ensure that no part of Wallaby Warmer or related components is immersed in any cleaning liquid or cleaning solution.
- Do not clean the infant radiant warmer heating element.
- Do not use abrasive cleaning solutions.
- Ensure all Wallaby Warmer parts and components are checked before returning the device to service.

Cleaning

Skin Sensors

- Do not autoclave or gas sterilise the Wallaby skin sensors.
 - Do not pull on the sensor cup or sensor plug during the cleaning or drying as the skin sensor may be damaged.
 - Ensure the skin sensor is only removed from the controller by grasping the plug at the front panel. Ensure excessive strain is not placed on the sensor lead either during use, cleaning or inspection.
1. Clean Wallaby skin sensors with alcohol, or detergent or soap solution (maximum 2% in water), ensuring the manufacturer's directions for use of the cleaning agent are followed.
 2. Apply the cleaning solution with clean cloth or sponge, and dry all surfaces after cleaning with a clean soft cloth or paper towel.

Mattress

NOTE

- Do not autoclave or gas sterilise the mattress.
1. Clean the mattress with an approved and correctly diluted disinfectant-detergent solution, ensuring the manufacturer's directions for use of the cleaning agent are followed.
 2. Apply the cleaning solution with clean cloth or sponge, and dry all surfaces after cleaning with a clean soft cloth or paper towel.

Maintenance

- Only qualified personnel should carry out service and maintenance procedures.
- To avoid the possibility of burns when performing maintenance procedures, ensure the warmer is disconnected from the power supply by removing the plug from the mains outlet and the heater element is allowed to cool for one hour.
- To avoid the possibility of electric shock hazard when performing the maintenance procedures, ensure the warmer is disconnected from the power supply by removing the plug from the mains outlet.
- After the maintenance is completed, ensure the equipment is functioning correctly in accordance with the published performance specifications.
- Ensure only approved replacement parts are used during service and maintenance procedures.
- Please contact an authorised MTTTS representative for further assistance with any servicing or maintenance requirement.

Bed and X-ray tray

Bed should be checked annually to ensure reliable operation. The following procedure should be used by your technician:

1. Check each bed side panel for smooth operation and correct latching. Replace if defective.
2. Check X-ray tray module for smooth operation and correct placement of X-ray cassette. Replace if defective.
3. Check the operation of the tilt mechanism for smooth movement and that appropriate resistance can be felt.
4. Check that M6x120 bolt, which the bed pivots on is not loos. Tighten if necessary.

Maintenance

Base

The base should be checked at least annually to ensure reliable operation. The following procedure should be used by your technician:

1. Check all base fittings are secure.
2. Check castors rotate freely and castor brakes operate correctly.

Overhead Unit

1. At least annually check the overhead unit swivel is secure.
2. Ensure that overhead unit pivot nuts are locked in place. Check the swivel movement of the unit is free and that the central position can be locked correctly.

Heater Element

1. Estimated lifetime of the Heater Element is 10,000 hours.
2. When the Wallaby Warmer main unit cannot detect Heater current (due to exceeded lifetime or Heater Element failure), error **E3** is displayed.
3. Refer to the Technical Manual for Heater Element replacement instructions.

Disposal

1. This medical device is classified as electrical and electronic equipment (EEE) as per 2012/19/EU
2. The presence of hazardous substances in EEE poses serious environmental risks (soil contamination, water pollution, air pollution, biodiversity loss, resource depletion) and health risks (toxic exposure, neurological damage, cancer risk, respiratory issues, reproductive health issues).
3. Users have a vital role in the lifecycle of electronic products. By taking proactive steps in re-use, recycling, and recovery, they can significantly reduce the environmental impact of waste electrical and electronic equipment (WEEE) and contribute to a more sustainable future.

NOTE

- Do not dispose of (WEEE) as unsorted municipal waste and to collect such WEEE separately.
- Return the medical device considered to be WEEE to the nearest collection point when it's ready for disposal. The collection points near you can be found here: <https://weee-directory.com/>

Specifications

Performance Specifications

Radiation source	Ceramic infrared heating element 650W Wavelength: 2 - 10 μW
Heating element duration	10,000 hours
Effective surface area	54 cm x 64 cm
Expected service life	5 years

Physical Specifications

Dimensions (LxWxD)	110 cm x 78 cm x 174 cm
Total unit mass	64 kg
Maximum load	20 kg
Alarms	<p>Medium Priority Audible 3 pulse burst, followed by 3 second delay</p> <p>Medium Priority Visual Yellow flashing at 0.5 Hz</p> <p>High Priority Audible (Power out) 4kHz continuous buzzer tone</p> <p>Alarm Volume >50 dBA at a distance of 1 meter</p>
Heater element to mattress	70 cm
Overhead unit rotation	-88° to +88° from the centre position
Mattress	<p>Material Waterproof PU</p> <p>Foam Density 22kg/m³</p> <p>Size 54 x 64 cm</p> <p>Height 90 cm</p>
Bed tilting positions	-12° to +12°
Castors	4 x 100mm, all locking
Monitor / Storage tray	30 x 20 cm
X-ray cassette	<p>Size 26 x 70 cm</p> <p>Thickness 1 mm</p>

Electrical Specifications

Power characteristics	220-240V AC, 47/63Hz
Protection against electric shock	Class I
Nominal power consumption	650W
Heater power	650W
Light power	3W LED - Maximum intensity 425 lux
Temperature range	<p>Displayed range / resolution 10°C - 50°C / 0.1°C</p> <p>Setting range / resolution 34°C - 37.5°C / 0.1°C</p>
Temperature measurement	Sensor accuracy / range ±0.3°C / 30°C - 40°C

Power Cords	<p>North America (part 50-07302-01)</p> <p>C.E. (part 50-07305-01)</p> <p>U.K. (part 50-09273-01)</p>
-------------	---

Specifications

Environmental Specifications

Operating	<p>Ambient temperature +18°C to +35°C</p> <p>Humidity: 30% to 90% RH non condensing</p> <p>Atmospheric Pressure: 70-106kPa</p>
Transport and storage	<p>Ambient temperature 0°C to +50°C</p> <p>Humidity: 5% to 90% RH non condensing</p> <p>Atmospheric Pressure: 70-106kPa</p>
Exclusions	None

Standards for Reference

EN ISO 13485:2016+A11:2021
 EN ISO 14971:2019+A11:2021
 ISO/TR 24971:2020
 EN 60601-1:2006/A1:2013
 EN 60601-2-21:2009 + A11:2011 + A1:2016
 EN 60601-1-2:2015
 EN 60601-1-6:2010 + A1:2015
 EN 60601-1-8:2007 + A1:2013 + A11:2017
 EN ISO 10993-1:2020
 EN 62304:2006/A1:2015
 EN ISO 15223-1:2021
 EN ISO 20417:2021
 MEDDEV 2.7/1 rev. 4
 MEDDEV 2.12/1 rev. 8
 MEDDEV 2.12/2 rev. 2
 ROHS 2011/65/EU
 WEEE 2012/19/EU

Explanation of Symbols



WARNING. Not following this statement could result in injury to the patient or operator, or damage to the device.



Authorized Representative in the European Community



CE Marking with Notified Body Number.



Device manufacturer.



Consult instructions for use or the electronic instructions for use (ISO 15223-1)



Date of manufacture (YYYY-MM)



Consult instructions for use or the electronic instructions for use (EN 60601-1)



Hot surface.



Medical device



Liquid ingress protection - level 0 (no protection against water)



Unique device identifier



Maximum load.



Model number



Type BF applied part



Catalogue number



Temperature limit



Serial number.



Humidity limitation



Website where a user can obtain additional information on the medical product



Atmospheric pressure limitation



This device contains electronic parts. Do not dispose of it with normal waste. Dispose of it according to local guidelines for disposal of electronics. Dispose according to the WEEE directive in the European Union.

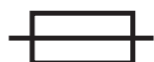

Type and full rating of fuse

Warranty Policy

General Terms

This MTTs Limited Warranty gives you, the customer, express limited warranty rights from MTTs, the manufacturer for the duration specified on the Warranty Card. Please refer to the MTTs Website for an extensive description of your limited warranty entitlements. In addition, you may also have other legal rights under applicable law or special written agreement with MTTs.

MTTS MAKES NO OTHER EXPRESS WARRANTY OR CONDITION WHETHER WRITTEN OR ORAL AND MTTS EXPRESSLY DISCLAIMS ALL WARRANTIES AND CONDITIONS NOT STATED IN THIS LIMITED WARRANTY. TO THE EXTENT ALLOWED BY LOCAL LAW OF JURISDICTIONS OUTSIDE VIETNAM, MTTS DISCLAIMS ALL IMPLIED WARRANTIES OR CONDITIONS, INCLUDING ANY IMPLIED WARRANTIES OF MERCHANTABILITY AND FITNESS FOR A PARTICULAR PURPOSE. FOR ALL TRANSACTIONS OCCURRING IN VIETNAM ANY IMPLIED WARRANTY OR CONDITION OF MERCHANTABILITY, SATISFACTORY QUALITY, OR FITNESS FOR A PARTICULAR PURPOSE IS LIMITED TO THE DURATION OF THE EXPRESS WARRANTY SET FORTH ABOVE. SOME COUNTRIES DO NOT ALLOW A LIMITATION ON HOW LONG AN IMPLIED WARRANTY LASTS OR THE EXCLUSION OR LIMITATION OF INCIDENTAL OR CONSEQUENTIAL DAMAGES FOR CONSUMER PRODUCTS. IN SUCH COUNTRIES, SOME EXCLUSIONS OR LIMITATIONS OF THIS LIMITED WARRANTY MAY NOT APPLY TO YOU. FOR CONSUMER TRANSACTION, THE LIMITED WARRANTY TERMS CONTAINED IN THIS STATEMENT, EXCEPT TO THE EXTENT LAWFULLY PERMITTED, DO NOT EXCLUDE, RESTRICT, OR MODIFY BUT ARE IN ADDITION TO THE MANDATORY STATUTORY RIGHTS APPLICABLE TO THE SALE OF THIS PRODUCT TO YOU.

This Limited Warranty is applicable in all countries and may be enforced in any country or region where MTTs or its authorized service providers offer warranty service for the same product model number (subject to the terms and conditions set forth in this Limited Warranty)

Under this Limited Warranty, products purchased in one country or region may be transferred to another country or region where MTTs or its authorized service providers offer warranty service for the same product model number. Warranty terms, service availability, and service response times may vary from country or region to country or region. Standard warranty service response time is subject to change due to local parts availability. If so, your MTTs authorized service provider can provide you with details. MTTs will not alter form, fit, or function of this MTTs product to make it operate in a country for which it was never intended to function for legal or regulatory reasons. MTTs is not responsible for any tariffs or duties that may be incurred in transferring the products.

MTTS guarantees that the product that you have purchased or leased from MTTs is free from defects in materials or workmanship under normal use during Limited Warranty Period. The Limited Warranty Period starts on the date of purchase or lease from MTTs, or from the date MTTs completes installation. Your dated sales or delivery receipt, showing the date of purchase of the product, is your proof of the purchase or lease date. You may be required to provide proof of purchase or lease as a condition of receiving warranty service. You are entitled to hardware warranty service according to the terms and conditions of this document if a repair to your MTTs product is required within the Limited Warranty Period.

Unless otherwise stated, and to the extent permitted by local law, new MTTs product may be manufactured using new materials and used materials equivalent to new in performance and reliability. MTTs may repair or replace MTTs products (a) with new or previously used products or parts equivalent to new in performance and reliability, or (b) with equivalent products to an original product that has been discontinued. Replacement parts are warranted to be free from defects in material or workmanship for ninety (90) days or, for the remainder of Limited Warranty Period of the MTTs product they are replacing or in which they are installed, whichever is longer.

Warranty Policy

MTTS will, at its sole discretion, repair or replace any components or product that manifests a defect in materials or workmanship during the Limited Warranty Period. All component parts removed under this Limited Warranty become the property of MTTS. In the unlikely event that your MTTS product has recurring failures, MTTS at its sole discretion, may elect to provide you with (a) a replacement unit selected by MTTS that is the same or equivalent to your MTTS product in performance or (b) to give you a refund of your purchase price or lease payments (less interests) instead of a replacement. This is your exclusive remedy for defective products.

Exclusions

MTTS DOES NOT WARRANT THAT THE OPERATION OF THIS PRODUCT WILL BE UNINTERRUPTED OR ERROR-FREE. MTTS IS NOT RESPONSIBLE FOR DAMAGE THAT OCCURS AS RESULT OF YOUR FAILURE TO FOLLOW THE INSTRUCTIONS INTENDED FOR THE PRODUCT.

This Limited Warranty does not apply to expendable or consumable parts and does not extend to any product from which the serial number has been removed or that has been damaged or rendered defective (a) as a result of accident, misuse, abuse, contamination, improper or inadequate maintenance or calibration (if required) or other external causes; (b) by operation outside the usage parameters stated in the user documentation shipped with the product; (c) by software, interfacing, parts or supplies not supplied by MTTS; (d) improper site preparation or maintenance; (e) virus infection; (f) loss or damage in transit ; or (g) by modification or service by anyone other than (i) MTTS personnel, (ii) an MTTS authorized service provider, or (iii) your own installation of end-user replaceable MTTS or MTTS approved parts if available for your MTTS product in the servicing country or region.

Limitation of Liability

IF YOUR MTTS PRODUCT FAILS TO WORK AS WARRANTED ABOVE, THE MAXIMUM LIABILITY OF MTTS UNDER THIS LIMITED WARRANTY IS EXPRESSLY LIMITED TO THE LESSER OF THE PRICE YOU HAVE PAID FOR THE PRODUCT OR THE COSTS OF REPAIR OR REPLACEMENT OF ANY HARDWARE COMPONENTS THAT MALFUNCTION IN CONDITIONS OF NORMAL USE.

EXCEPT AS INDICATED ABOVE, IN NO EVENT WILL MTTS BE LIABLE FOR ANY DAMAGES CAUSED BY THE PRODUCT OR THE FAILURE OF THE PRODUCT TO PERFORM, INCLUDING ANY LOST PROFITS OR SAVINGS OR SPECIAL, INCIDENTAL, OR CONSEQUENTIAL DAMAGES. MTTS IS NOT LIABLE FOR ANY CLAIM MADE BY A THIRD PARTY OR MADE BY YOU FOR A THIRD PARTY.

THIS LIMITATION OF LIABILITY APPLIES WHETHER DAMAGES ARE SOUGHT, OR CLAIM MADE, UNDER THIS LIMITED WARRANTY OR AS A TORT CLAIM (INCLUDING NEGLIGENCE AND STRICT PRODUCT LIABILITY), A CONTRACT CLAIM, OR ANY OTHER CLAIM. THIS LIMITATION LIABILITY CANNOT BE WAIVED OR AMENDED BY ANY PERSON. THIS LIMITATION OF LIABILITY WILL BE EFFECTIVE EVEN IF YOU HAVE ADVISED MTTS OF THE POSSIBILITY OF ANY SUCH DAMAGES. THIS LIMITATION OF LIABILITY, HOWEVER, WILL NOT APPLY TO CLAIMS FOR PERSONAL INJURY.

THIS LIMITED WARRANTY GIVES YOU SPECIFIC LEGAL RIGHTS. YOU MAY ALSO HAVE OTHER RIGHTS THAT MAY VARY FROM COUNTRY TO COUNTRY. YOU ARE ADVISED TO CONSULT APPLICABLE COUNTRY LAWS FOR A FULL DETERMINATION OF YOUR RIGHTS.

Warranty Policy

Limited Warranty Period

The Limited Warranty Period for this MTTS product is a specified, fixed period commencing on the date of purchase and specified on the Warranty Card. The date on your sales receipt is the date of purchase unless MTTS or your reseller informs you otherwise in writing.

Customer Responsibilities

In order to avoid the risk of charges for issues not covered by your limited warranty (issues that are not due to defects in materials and workmanship on MTTS product), you will be asked to assist MTTS as follows:

- Verify configurations, load most recent firmware, install software patches, run MTTS diagnostics and utilities;
- Implement temporary procedures or workarounds provided by MTTS while MTTS works on permanent solution;
- Cooperate with MTTS in attempting to resolve the problem using online chat, email, or telephone. This may involve performing routine diagnostic procedures, installing additional software updates or patches;
- Perform additional tasks as defined within each type of warranty service provided by MTTS and any other actions that MTTS may reasonably request in order to best perform the warranty support

CUSTOMER IS RESPONSIBLE FOR DELIVERING THE PRODUCT (AND ALL COSTS INVOLVED) FROM HIS LOCATION TO THE MTTS AUTHORIZED SERVICE POINT.

Contacting MTTS

If your MTTS product fails during the Limited Warranty Period and the suggestions in the product documentation do not solve the problem, you can receive support by doing one of the following:

- Locate and contact your nearest MTTS service provider via MTTS website:
<http://www.mtts-asia.com/support/>
- Call the Technical Support Centre:
+84 43 766 6521

Before calling MTTS or an MTTS authorized service provider please have the following information available:

- Product serial number and model name
- Applicable error messages
- Detailed questions



MEDICAL TECHNOLOGY TRANSFER AND SERVICES Co., LTD
House No. 26, Alley 41, An Duong Vuong Street, Tay Ho District, Hanoi City, Vietnam
SRN: VN-MF-000036669

Tel: +84 24 3766 6521
Fax: +84 24 3718 8050
Email: assistance@mtts-asia.com
www.mtts-asia.com



EC REP

Logic s.r.l.
Via Antonio Pigafetta 1
34147 Trieste, Italy
SRN: IT-AR-000012301

